



高瑞电气
GAORUI ELECTRIC



高瑞电气
GAORUI ELECTRIC

CHANGZHOU GAORUI ELECTRIC CO.,LTD.

Factory Add: NiuTang Town, Wujin, Changzhou, Jiangsu, China

Tel: 0086-519-67890285

Fax: 0086-519-81081302

Website: www.lampshouse.com

Email: david@lampshouse.com



Bright and ECO-friendly



Changzhou GaoRui Electric Co., Ltd. was established in **1990s**, located in Changzhou, Jiangsu, China, with more than 20000 m² plant, more than 200 staffs.

Our factory focuses on the middle and high-end LED lighting products. Our main Item include: **LED flood light; LED high bay; LED tunnel lamp; LED street lamps**. Products are widely used in outdoor lighting, warehouse and plant lighting, tunnel lighting, road lighting and other applications.

Gaorui have more than 10 years of LED lighting R & D, production, sales experience; we cooperate with world famous manufacturers: **CREE, Bridgelux, PHILIPS, Samsung and Mean Well** and give 3 to 5 years warranty for products to our customer. And our company passed the **ISO9001:2015** international quality standard system certifications, the products passed the: **CE, ETL, TUV, ERP, ROHS, NOM** and other related certification.

We also have a professional and perfect pre-sale, sale, after-sales customer service and management system, our target is "satisfying every customer with fine-chosen materials, strict manufacturing technology, assured good quality and good service", the whole staffs from gaorui sincerely welcome the customer from all over the world to talk business and make cooperation with us. Hope we can be trustworthy partner in near future!



STRATEGIC COOPERATION

LED LIGHT SOURCE



AUTONOMY IN PACKAGE OF LED LIGHT SOURCE



The Magic of Light®

LED DRIVER SUPPLY



INVENTRONICS
英飞特电子



Contents

LED FLOOD LIGHT	01-19
LED STREET LIGHT	20-35
LED HIGHBAY	36-47
LED GARDEN LIGHT	48-51
LED MODULE LIGHT	52
LED SOLAR ENERGY	53-67



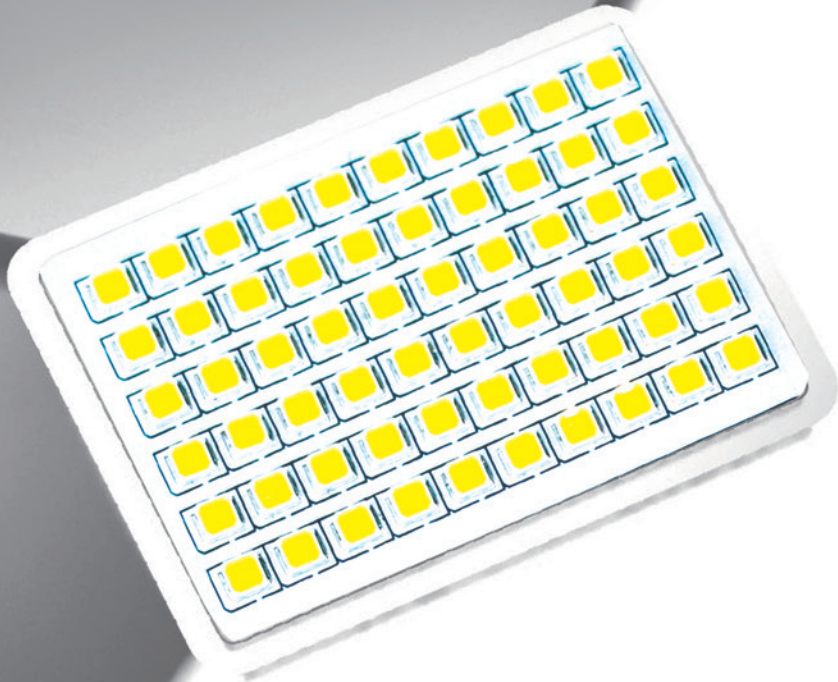



Slim LED Flood Light

Attractive design and excellent appearance

Eco-Friendly

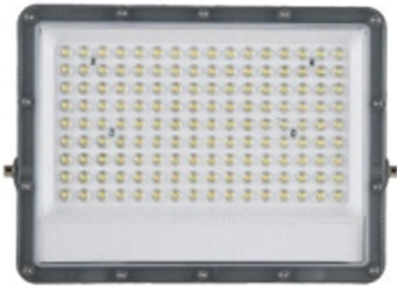
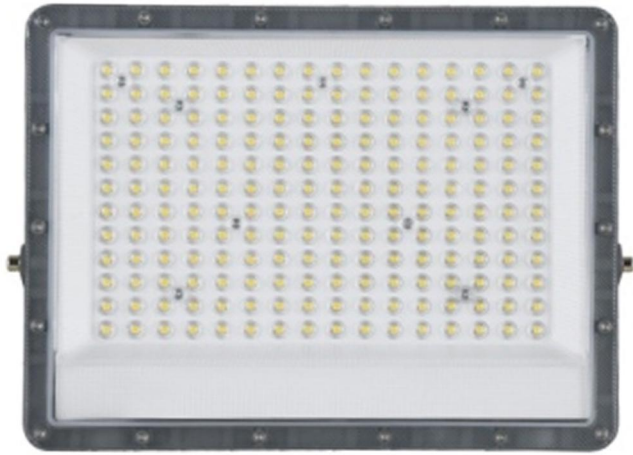

Application:

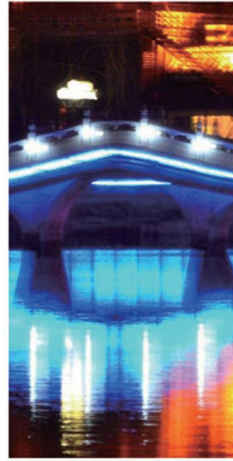

Feature

- Ultra-thin design and the shape is unique.
- Alu die casting material and high-tech spraying technology, never rust, never corrosion.
- Using new technology to ensure the integrity of the fixture is good, reliable sealing, waterproof. Heat dissipation quickly, long life.

Item No.	Wattage	Lumen	Size(LxWxH)
GR1050	30W	3000	L162 W122 H26
GR1050	50W	5000	L208 W161 H31
GR1050	100W	10000	L271 W211 H31
GR1050	150W	15000	L330 W251 H36
GR1050	200W	20000	L380 W280 H38

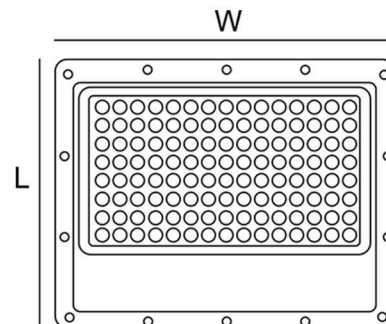



Feature

- Ultra-thin design and the shape is unique.
- Alu die casting material and high-tech spraying technology, never rust, never corrosion.
- Using new technology to ensure the integrity of the fixture is good, reliable sealing, waterproof.
- Heat dissipation quickly, long life.

Item No.	Wattage	Material	Size(LxWxH)
GR1051	50W	Aluminium+Glass	235*27*195
GR1051	100W	Aluminium+Glass	295*26*233
GR1051	150W	Aluminium+Glass	358*27*272
GR1051	200W	Aluminium+Glass	385*27*328

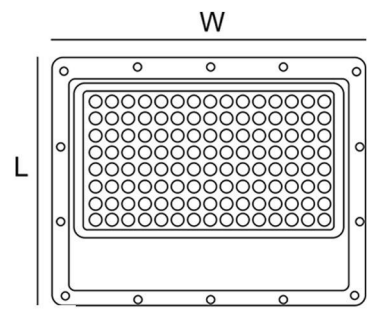



Feature

- Ultra-thin design and the shape is unique.
- Alu die casting material and high-tech spraying technology, never rust, never corrosion.
- Using new technology to ensure the integrity of the fixture is good, reliable sealing, waterproof.
- Heat dissipation quickly, long life.

Item No.	Wattage	Materials	Size(LxWxH)
GR1052	50W	AL+GLASS	202*173*26MM
GR1052	100W	AL+GLASS	254*220*28MM
GR1052	150W	AL+GLASS	313*265*30MM
GR1052	200W	AL+GLASS	342*298*35MM
GR1052	300W	AL+GLASS	376*328*35MM

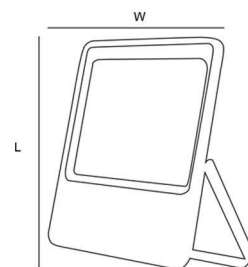



Feature

- Ultra-thin design and the shape is unique.
- Alu die casting material and high-tech spraying technology, never rust, never corrosion.
- Using new technology to ensure the integrity of the fixture is good, reliable sealing, waterproof.
- Heat dissipation quickly, long life.

Item No.	Wattage	LED Type	Materials	Size(LxWxH)
GR1053	10W	SMD 2835	AL+GLASS	100*85*21mm
GR1053	20W	SMD 2835	AL+GLASS	120*103*21mm
GR1053	30W	SMD 2835	AL+GLASS	156*135*26mm
GR1053	50W	SMD 2835	AL+GLASS	191*164*30mm
GR1053	100W	SMD 2835	AL+GLASS	231*198*30mm
GR1053	150W	SMD 2835	AL+GLASS	267*230*31mm
GR1053	200W	SMD 2835	AL+GLASS	386*265*31mm

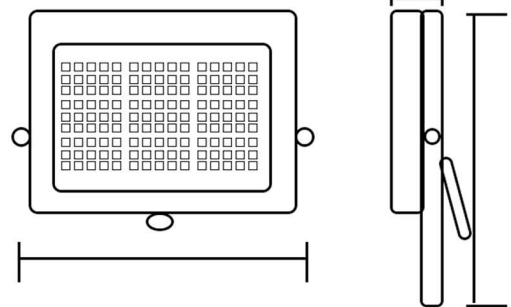



Feature

- Ultra-thin design and the shape is unique.
- Alu die casting material and high-tech spraying technology, never rust, never corrosion.
- Using new technology to ensure the integrity of the fixture is good, reliable sealing, waterproof.
- Heat dissipation quickly, long life.

Item No.	Wattage	Material	Size(LxWxH)
GR1054	50W	Aluminium+Glass	235*27*195
GR1054	100W	Aluminium+Glass	295*26*233
GR1054	150W	Aluminium+Glass	358*27*272
GR1054	200W	Aluminium+Glass	385*27*328

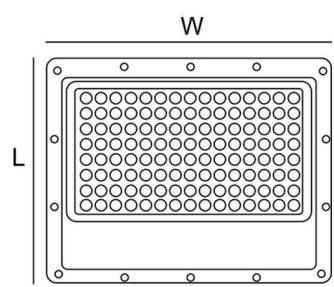



Feature

- Ultra-thin design and the shape is unique.
- Alu die casting material and high-tech spraying technology, never rust, never corrosion.
- Using new technology to ensure the integrity of the fixture is good, reliable sealing, waterproof.
- Heat dissipation quickly, long life.

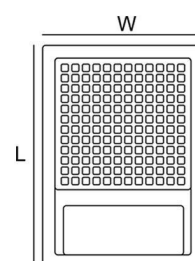

Item No.	Wattage	Lumen	Material	Size(LxWxH)
GR1055	50W	6500LM	Die-castAluminum+Tempered Glass	175*45*245
GR1055	100W	13000LM	Die-castAluminum+Tempered Glass	235*50*325
GR1055	150W	18000LM	Die-castAluminum+Tempered Glass	285*55*345
GR1055	200W	24000LM	Die-castAluminum+Tempered Glass	325*75*405
GR1055	300W	35000LM	Die-castAluminum+Tempered Glass	375*75*475
GR1055	400W	43000LM	Die-castAluminum+Tempered Glass	425*80*545



Feature

- Ultra-thin design and the shape is unique.
- Alu die casting material and high-tech spraying technology, never rust, never corrosion.
- Using new technology to ensure the integrity of the fixture is good, reliable sealing, waterproof.
- Heat dissipation quickly, long life.

Item No.	Wattage	Lumen	Material
GR1056	10WD75	1000Lm	Aluminum
GR1056	20WD75	1500Lm	Aluminum
GR1056	30WD75	2000Lm	Aluminum
GR1056	50WD75	3700Lm	Aluminum
GR1056	100WD75	7500Lm	Aluminum
GR1056	150WD75	11200Lm	Aluminum
GR1056	200WD75	15000Lm	Aluminum

Application:





Feature

- Ultra-thin design and the shape is unique.
- Alu die casting material and high-tech spraying technology, never rust, never corrosion.
- Using new technology to ensure the integrity of the fixture is good, reliable sealing, waterproof.
- Heat dissipation quickly, long life.

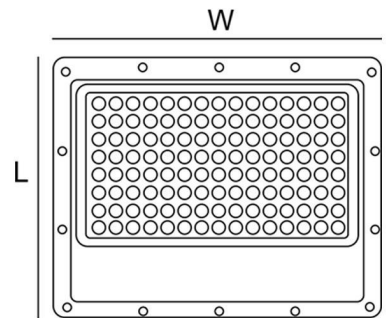

Application:

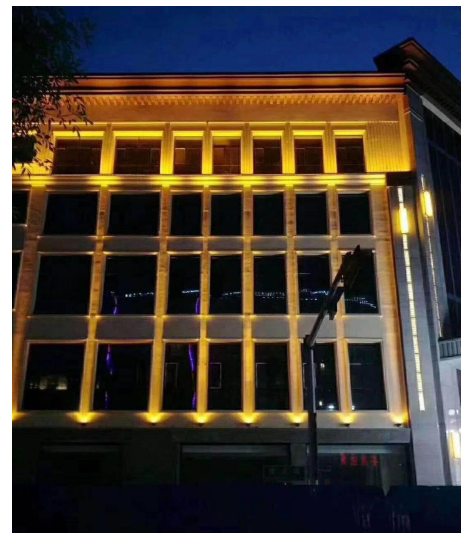

Item No.	Wattage	Lumen	Material
GR1057	10W	1000LM	Alu.
GR1057	20W	2000LM	Alu.
GR1057	30W	3000LM	Alu.
GR1057	50W	5000LM	Alu.
GR1057	70W	7000LM	Alu.
GR1057	100W	10000LM	Alu.
GR1057	150W	15000LM	Alu.
GR1057	200W	20000LM	Alu.
GR1057	400W	40000LM	Alu.



Feature

- Innovative and compact design.
- Durable housing, Excellent appearance.

Application:



Item No.	Wattage	Lumen	Material
GR1058	10W	1000LM	Alu.
GR1058	20W	2000LM	Alu.
GR1058	30W	3000LM	Alu.
GR1058	50W	5000LM	Alu.
GR1058	70W	7000LM	Alu.
GR1058	100W	10000LM	Alu.
GR1058	150W	15000LM	Alu.
GR1058	200W	20000LM	Alu.



Application:



Available color:



Feature

- Ultra-thin design and the shape is unique.
- Alu die casting material and high-tech spraying technology, never rust, never corrosion.
- Using new technology to ensure the integrity of the fixture is good, reliable sealing, waterproof.
- Heat dissipation quickly, long life.

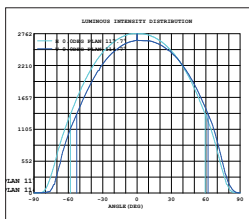
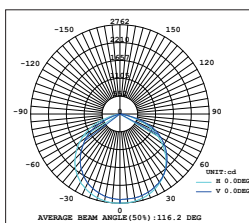
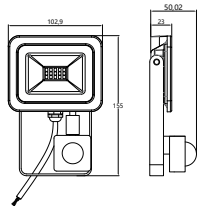

Item No.	Wattage	Lumen	LED Type	Material	Size(LxWxH)
GR1047	10W	800lm	SMD2835	Alu.	102.75x24x82.75mm
GR1047	20W	1600lm	SMD2835	Alu.	121x23x95mm
GR1047	30W	2400lm	SMD2835	Alu.	159.25x25.95x121.75mm
GR1047	50W	4000lm	SMD2835	Alu.	205.47x33.50x159.67mm
GR1047	100W	8000lm	SMD2835	Alu.	269.74x33.49x209.74mm
GR1047	120W	9600lm	SMD2835	Alu.	298x36x231mm
GR1047	150W	12000lm	SMD2835	Alu.	298x36x231mm
GR1047	200W	16000lm	SMD2835	Alu.	379.81x43.52x279.81mm
GR1047	300W	24000lm	SMD2835	Alu.	460.20x43.52x338.94mm

Application:



Available color:



Feature

- Ultra-thin design and the shape is unique.
- Alu die casting material and high-tech spraying technology, never rust, never corrosion.
- Using new technology to ensure the integrity of the fixture is good, reliable sealing, waterproof.
- Heat dissipation quickly, long life.

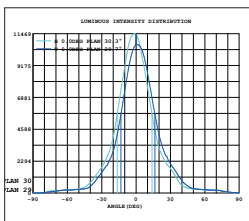
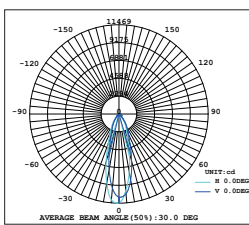
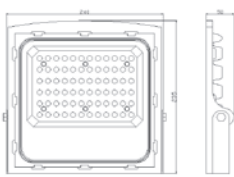

Item No.	Wattage	Lumen	LED Type	Material	Size(LxWxH)
GR1049	50W	≥ 115lm	SANAN3030	Alu.	240x50x235mm
GR1049	100W	≥ 115lm	SANAN3030	Alu.	290x50x275mm
GR1049	150W	≥ 115lm	SANAN3030	Alu.	325x50x320mm
GR1049	200W	≥ 115lm	SANAN3030	Alu.	365x50x355mm

Application:



Available color:



Feature

- Ultra-thin design and the shape is unique.
- Alu die casting material and high-tech spraying technology, never rust, never corrosion.
- Using new technology to ensure the integrity of the fixture is good, reliable sealing, waterproof.
- Heat dissipation quickly, long life.

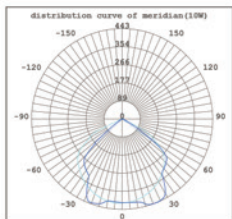
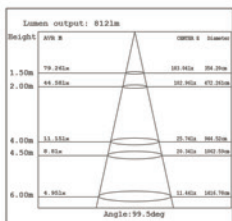
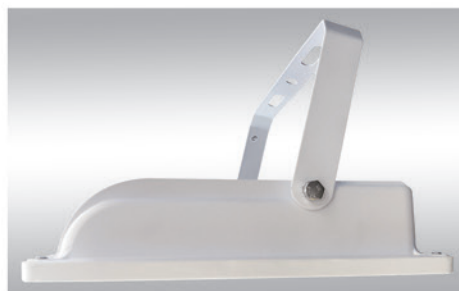
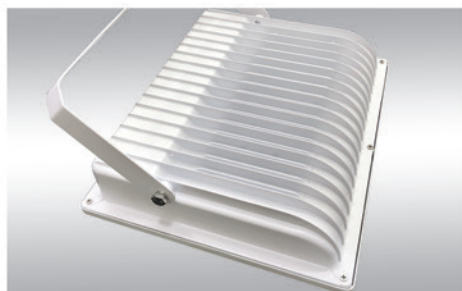
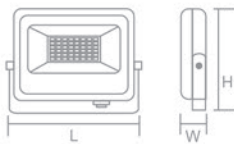

Item No.	Wattage	Lumen	Material	LED Type	Size(LxWxH)
GR1013A	10W	800lm	Alu.	SMD5730	112×30×105mm
GR1013A	20W	1600lm	Alu.	SMD5730	135×36×115mm
GR1013A	30W	2400lm	Alu.	SMD5730	185×44×155mm
GR1013A	50W	4000lm	Alu.	SMD5730	230×45×195mm
GR1013A	100W	8000lm	Alu.	SMD5730	285×55×240mm
GR1013A	150W	12000lm	Alu.	SMD5730	345×70×280mm
GR1013A	200W	16000lm	Alu.	SMD5730	425×80×325mm
GR1013A	400W	32000lm	Alu.	SMD5730	595×95×475mm



Application:



Available color:



Feature

- Innovative and compact design.
- Durable housing, Excellent appearance.
- Fin cooling module, its good for heat radiation of led floodlight.
- G-buckle technology, prevent glass off, convenient in assembly.



*Max. 10m



*Delay time 3-300sec (adjustable)



*Detective Range 180°

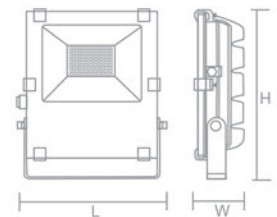

Item No.	Wattage	Lumen	LED Type	Material	Size(LxWxH)
GR1012A	10/W	800/1600lm	SMD2835/DOB	Alu.	135×45×160mm
GR1012A	30W	2400lm	SMD2835/DOB	Alu.	195×65×225mm
GR1012A	50/70W	4000/6400lm	SMD2835/DOB	Alu.	230×65×275mm
GR1012A	100W	8000lm	SMD2835/DOB	Alu.	280×85×350mm
GR1012A	150/200W	12000/16000lm	SMD2835/DOB	Alu.	330×85×440mm
GR1012A	250W	20000lm	SMD2835	Alu.	330×85×440mm
GR1012B	30W PIR	2400lm	SMD2835/DOB	Alu.	195×65×225mm
GR1012B	50/70W PIR	4000/5600lm	SMD2835/DOB	Alu.	230×65×275mm
GR1012B	100W PIR	8000lm	SMD2835/DOB	Alu.	280×85×350mm
GR1012B	150/200W PIR	12000/16000lm	SMD2835/DOB	Alu.	330×85×440mm
GR1012B	250W PIR	20000lm	SMD2835	Alu.	330×85×440mm

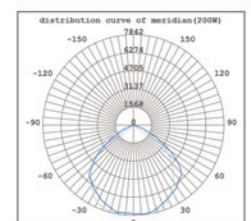
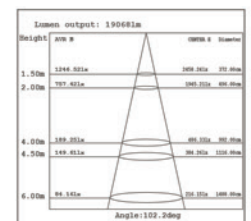

Application:



Available color:



Brightness/Speed Adjust

When it is in static monochrome mode, it can adjust the brightness to make it dimmable floodlight.
When it is in FLASH or FADE mode, it can adjust the speed.

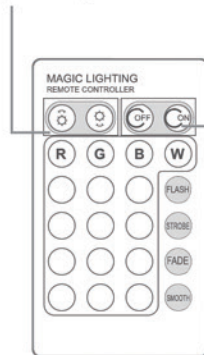

ON Button

When the light is off, press it to turn it on.
When the light is on, press it to suspend or continue.

Memory Function

The remote controller is with memory function, it can memorize and restore the setting of colour or mode before the power is off.

Feature

- Colour changing. 16 colour choices by remote controller (included).
- Dimmable. Controlled by remote controller (included).
- 4 Modes. Flash/Strobe/Fade/Smooth.
- Maintenance Free. Extremely long life reduces re-lamp frequency.
- Durable housing. Rugged die-cast aluminum, scratch and fade resistant.

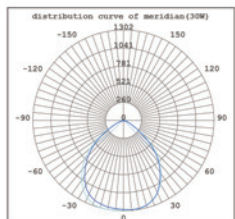
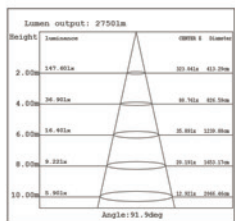
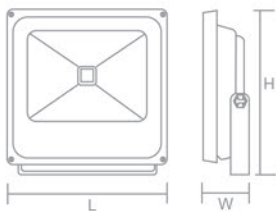

Item No.	Wattage	Light Color	LED Type	Material	Size(LxWxH)
GR1022	10W	RGB	COB	Alu.	119.7×127×36.5mm
GR1022	20W	RGB	COB	Alu.	188×203×45mm
GR1022	30W	RGB	COB	Alu.	225×245×50mm
GR1022	50W	RGB	COB	Alu.	285×300×70mm



Application:

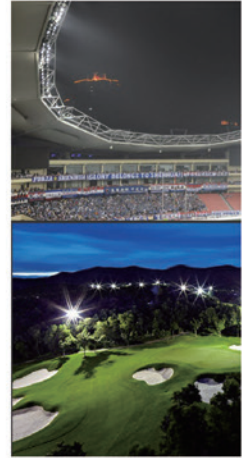

Available color:



Feature

- Integrated design big wattage led floodlight.
- Thickness alu die casting with tough glass.
- Good heat dissipation, extend the average life of the lamps.
- Safety, flexible, adjustable in any angle.

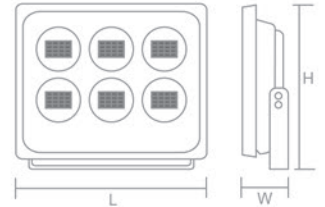

Item No.	Wattage	Lumen	LED Type	Material	Size(LxWxH)
GR1021	100W	8000lm	COB	Alu.	425×320×105mm
GR1021	200W	16000lm	COB	Alu.	435×320×110mm
GR1021	300W	24000lm	COB	Alu.	455×320×190mm
GR1021	400W	32000lm	COB	Alu.	560×320×200mm
GR1021	500W	40000lm	COB	Alu.	670×320×200mm
GR1021	600W	48000lm	COB	Alu.	800×320×200mm

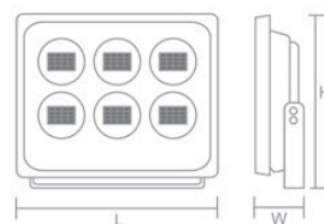

Feature

- Ultra-thin design and the shape is unique.
- Alu die casting material and high-tech spraying technology, never rust, never corrosion.
- Using new technology to ensure the integrity of the fixture is good, reliable sealing, waterproof.
- Heat dissipation quickly, long life.



Model	Power	Side	Lumen	Beam Angle
GR1059	50W	L228 W192 H56	5000	90°
GR1059	100W	L228 W243 H62	10000	90°
GR1059	150W	L350 W284 H75	15000	90°
GR1059	200W	L423 W323 H80	20000	90°
GR1059	300W	L460 W375 H85	30000	90°
GR1059	400W	L565 W382 H95	40000	90°
GR1059	500W	L670 W378 H95	50000	90°





Application:



Available color:



Feature

- New compact design led Stadium lamp, Excellent appearance.
- Save electricity bill. Replace HPS OR MH. Save over 50% on electricity bill of lighting.
- Maintenance Free. Extremely long life reduces re-lamp frequency.
- Durable housing. Rugged die-cast aluminum, scratch and fade resistant.
- Tempered and the frost Glass. Safe and extremely high light transmittance.
- No Hazardous Emissions. No UV or IR Radiation.

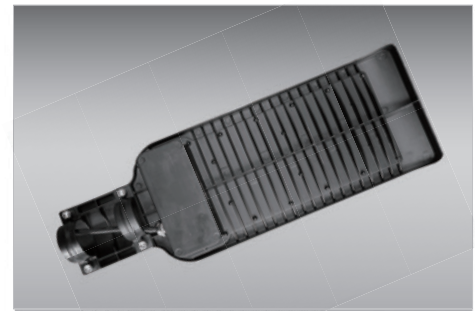
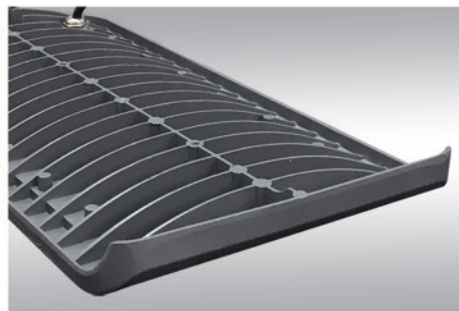
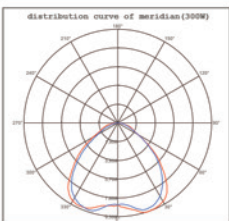
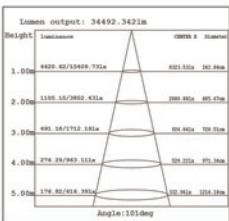
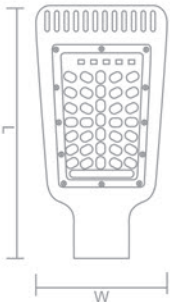

85-265V~
50/60Hz

PF
>0.9

TcT
3000-6500K

IP65

IK08

Ra
≥70

Beam angle
120°

30000h

Item No.	Wattage	Lumen	LED Type	Material	Size(LxWxH)
GR1119A	20W	1600LM	SMD2835	Alu.	285x110x35mm
GR1119A	30W	2400LM	SMD2835	Alu.	310x125x35mm
GR1119A	50W	4000LM	SMD2835	Alu.	345x140x45mm
GR1119A	100W	8000LM	SMD2835	Alu.	525x185x45mm
GR1119A	150W	12000LM	SMD2835	Alu.	620x180x60mm



Feature

- New compact design led Stadium lamp, Excellent appearance.
- Save electricity bill. Replace HPS OR MH. Save over 50% on electricity bill of lighting.
- Maintenance Free. Extremely long life reduces re-lamp frequency.
- Durable housing. Rugged die-cast aluminum, scratch and fade resistant.
- Tempered and the frost Glass. Safe and extremely high light transmittance.
- No Hazardous Emissions. No UV or IR Radiation.

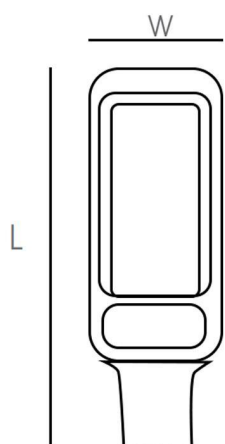

Item No.	Wattage	Material	Size(LxWxH)
GR1144	30W	Aluminium+PC	350*110*55MM
GR1144	50W	Aluminium+PC	410*120*55MM
GR1144	100W	Aluminium+PC	475*140*65MM
GR1144	150W	Aluminium+PC	585*160*75MM
GR1144	200W	Aluminium+PC	685*175*75MM



Feature

- New compact design led Stadium lamp, Excellent appearance.
- Save electricity bill. Replace HPS OR MH. Save over 50% on electricity bill of lighting.
- Maintenance Free. Extremely long life reduces re-lamp frequency.
- Durable housing. Rugged die-cast aluminum, scratch and fade resistant.
- Tempered and the frost Glass. Safe and extremely high light transmittance.
- No Hazardous Emissions. No UV or IR Radiation.

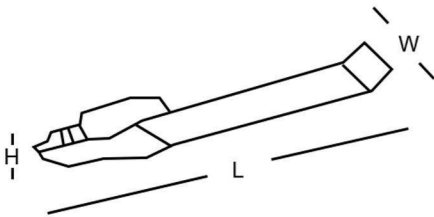

Model	Power	Lumen	Side	Beam angle	Operation Temperature	Voltage	Chip Model	IP
GR1145	30W	3000	L360W110H50	140*70°	-25°~65°	100~240V	EPISTAR	65
GR1145	40W	4000	L410W120H50	140*70°	-25°~65°	100~240V	EPISTAR	65
GR1145	60W	6000	L440W120H50	140*70°	-25°~65°	100~240V	EPISTAR	65
GR1145	90W	9000	L600W160H60	140*70°	-25°~65°	100~240V	EPISTAR	65
GR1145	120W	12000	L620W180H60	140*70°	-25°~65°	100~240V	EPISTAR	65
GR1145	150W	15000	L620W185H70	140*70°	-25°~65°	100~240V	EPISTAR	65



Feature

- Economy and compact design type.
- Save electricity bill. Replace HPS OR MH. Save over 50% on electricity bill of lighting.
- Maintenance Free. Extremely long life reduces re-lamp frequency.
- Durable housing. Rugged die-cast aluminum, scratch and fade resistant.
- Tempered and the frost Glass. Safe and extremely high light transmittance.
- No Hazardous Emissions. No UV or IR Radiation.

Item No.	Lumen	Wattage	Size(LxWxH)
GR1146	95-105LM/W	30W	390*120*70MM
GR1146	95-105LM/W	50W	470*155*70MM
GR1146	95-105LM/W	100W	540*175*75MM
GR1146	95-105LM/W	150W	600*195*86MM

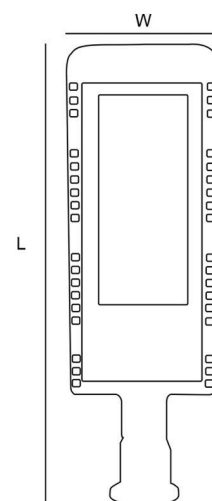



Feature

- Economy and compact design type.
- Save electricity bill. Replace HPS OR MH. Save over 50% on electricity bill of lighting.
- Maintenance Free. Extremely long life reduces re-lamp frequency.
- Durable housing. Rugged die-cast aluminum, scratch and fade resistant.
- Tempered and the frost Glass. Safe and extremely high light transmittance.
- No Hazardous Emissions. No UV or IR Radiation.



Item No.	Wattage	Material	Lumen	Size(LxWxH)
GR1147	30W	Aluminium+PC	3500LM	280*135*70
GR1147	50W	Aluminium+PC	6000LM	425*180*80
GR1147	100W	Aluminium+PC	12000LM	505*215*80
GR1147	150W	Aluminium+PC	18500LM	600*235*85
GR1147	200W	Aluminium+PC	22000LM	655*245*85
GR1147	250W	Aluminium+PC	30000LM	815*309*90
GR1147	300W	Aluminium+PC	30000LM	815*309*90

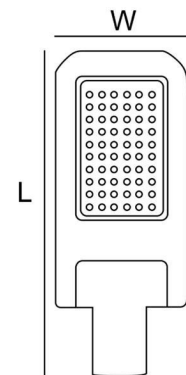

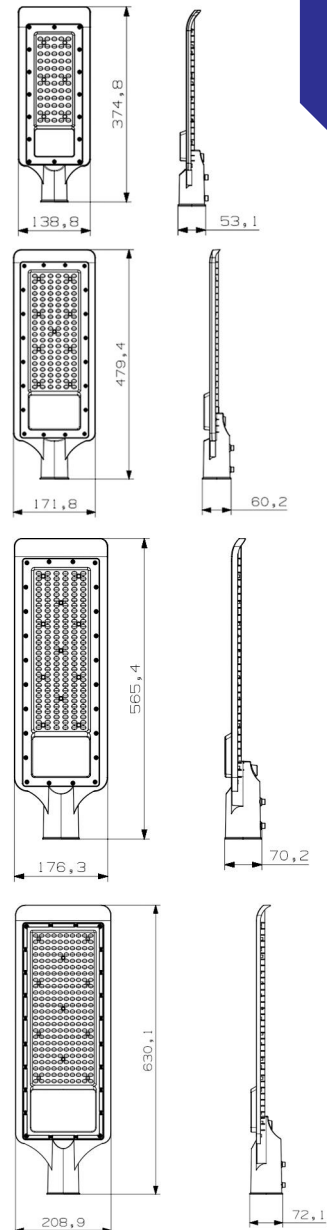

Feature

- Economy and compact design type.
- Save electricity bill. Replace HPS OR MH. Save over 50% on electricity bill of lighting.
- Maintenance Free. Extremely long life reduces re-lamp frequency.
- Durable housing. Rugged die-cast aluminum, scratch and fade resistant.
- Tempered and the frost Glass. Safe and extremely high light transmittance.
- No Hazardous Emissions. No UV or IR Radiation.



Item No.	Wattage	Material	Size(LxWxH)
GR1117	50W	Aluminium+PC	370*140*51
GR1117	100W	Aluminium+PC	480*172*59
GR1117	150W	Aluminium+PC	565*176*69
GR1117	200W	Aluminium+PC	630*219*69



Feature

- Economy and compact design type.
- Save electricity bill. Replace HPS OR MH. Save over 50% on electricity bill of lighting.
- Maintenance Free. Extremely long life reduces re-lamp frequency.
- Durable housing. Rugged die-cast aluminum, scratch and fade resistant.
- Tempered and the frost Glass. Safe and extremely high light transmittance.
- No Hazardous Emissions. No UV or IR Radiation.

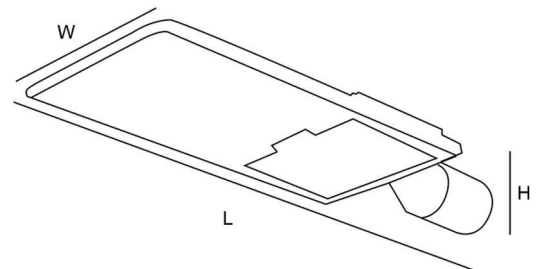

Item No.	Wattage	Lumen	Material	Size(LxWxH)
GR1148	50W	6500LM	Aluminium+PC	500*160*83
GR1148	100W	13500LM	Aluminium+PC	640*214*83
GR1148	150W	19000LM	Aluminium+PC	680*256*83
GR1148	200W	24000LM	Aluminium+PC	785*260*83



Feature

- New compact design led street lamp, Excellent appearance.
- Maintenance-free. Extremely long life reduces re-lamp frequency.
- Excellent lens design. Advanced and professional light distribution for street lighting.
- Durable housing. Rugged die-cast aluminum, scratch and fade resistant.
- No Hazardous Emissions. No UV or IR Radiation.

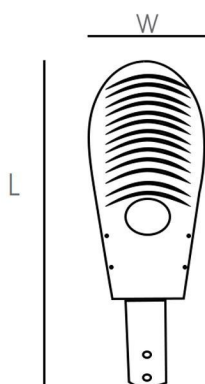

Item No.	Wattage	Lumen	Material	Size(LxWxH)
GR1150	50W	6000LM	Aluminium+PC	560*203*80
GR1150	100W	12000LM	Aluminium+PC	560*203*80
GR1150	150W	18500LM	Aluminium+PC	670*215*80
GR1150	200W	22000LM	Aluminium+PC	725*240*80



Feature

- New compact design led Stadium lamp, Excellent appearance.
- Save electricity bill. Replace HPS OR MH. Save over 50% on electricity bill of lighting.
- Maintenance Free. Extremely long life reduces re-lamp frequency.
- Durable housing. Rugged die-cast aluminum, scratch and fade resistant.
- Tempered and the frost Glass. Safe and extremely high light transmittance.
- No Hazardous Emissions. No UV or IR Radiation.

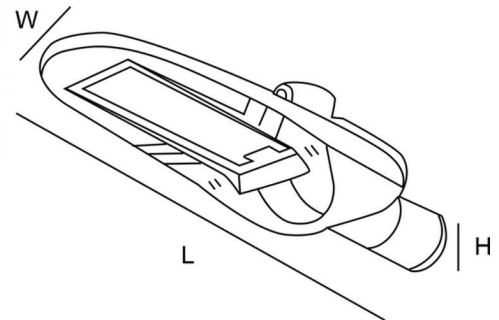

Item No.	Wattage	Lumen	Material	Size(LxWxH)
GR1149	50W	6500LM	Aluminium+PC	500*160*83
GR1149	100W	13500LM	Aluminium+PC	640*214*83
GR1149	150W	19000LM	Aluminium+PC	680*256*83
GR1149	200W	24000LM	Aluminium+PC	785*260*83



Application:



Available color:



Feature

- New compact design led street lamp, Excellent appearance.
- Maintenance-free. Extremely long life reduces re-lamp frequency.
- Excellent lens design. Advanced and professional light distribution for street lighting.
- Durable housing. Rugged die-cast aluminum, scratch and fade resistant.
- No Hazardous Emissions. No UV or IR Radiation.

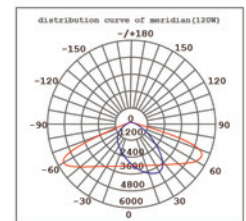
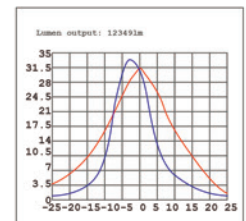
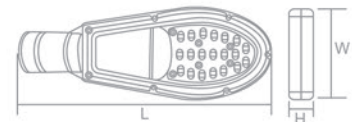
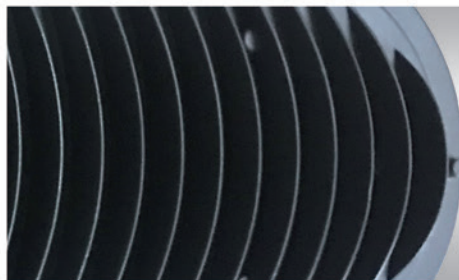

Item No.	Wattage	Lumen	LED Type	Material	Size(LxWxH)
GR1126	20W	2200lm	SMD2835	Alu.	330×128×58mm
GR1126	30W	3300lm	SMD2835	Alu.	370×140×58mm
GR1126	50W	5000lm	SMD2835	Alu.	430×175×58mm
GR1126	100W	10000lm	SMD2835	Alu.	580×230×83mm



Feature

- New compact design led street lamp, Excellent appearance.
- Maintenance-free. Extremely long life reduces re-lamp frequency.
- Excellent lens design. Advanced and professional light distribution for street lighting.
- Durable housing. Rugged die-cast aluminum, scratch and fade resistant.
- No Hazardous Emissions. No UV or IR Radiation.

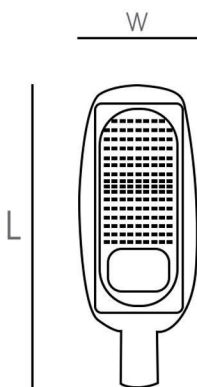

Item No.	Wattage	Lumen	Material	Size(LxWxH)
GR1151	50W	5000LM	Aluminium+PC	560*203*80
GR1151	100W	10000LM	Aluminium+PC	560*203*80
GR1151	150W	15000LM	Aluminium+PC	670*215*80

Application:



Available color:



Feature

- Excellent heat radiation, optical and electrical ability.
- Die-casting Aluminum body with powder-coating and anticorrosion treatment.
- Humanized design concept, easy to install and maintain.

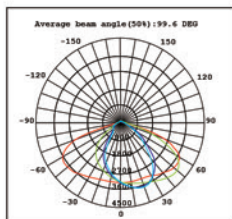
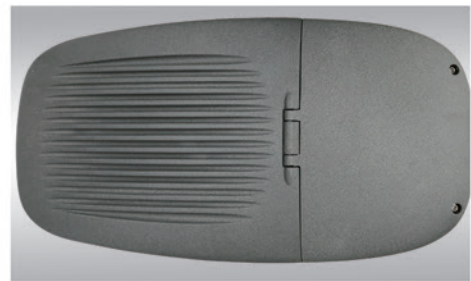
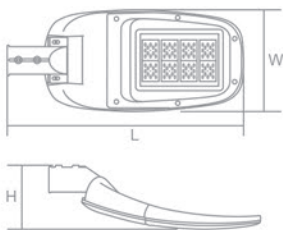

Item No.	Wattage	Lumen	LED Type	Material	Size(LxWxH)
GR1129	50W	120-145lm/w	SMD3030/5050	Alu.	520x212x90mm
GR1129	80W	120-145lm/w	SMD3030/5050	Alu.	616x259x186mm
GR1129	100W	120-145lm/w	SMD3030/5050	Alu.	677x305x187mm
GR1129	120W	120-145lm/w	SMD3030/5050	Alu.	677x305x187mm
GR1129	150W	120-145lm/w	SMD3030/5050	Alu.	850x366x198mm
GR1129	180W	120-145lm/w	SMD3030/5050	Alu.	850x366x198mm
GR1129	200W	120-145lm/w	SMD3030/5050	Alu.	850x366x198mm

Application:



Available color:



Feature

- Fashionable and modern appearance.
- Better heat radiation systems.
- Toughened glass, high strength, impact resistance.
- high reflection index anodized aluminum.

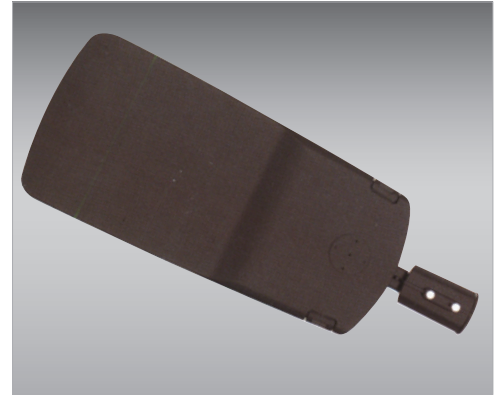
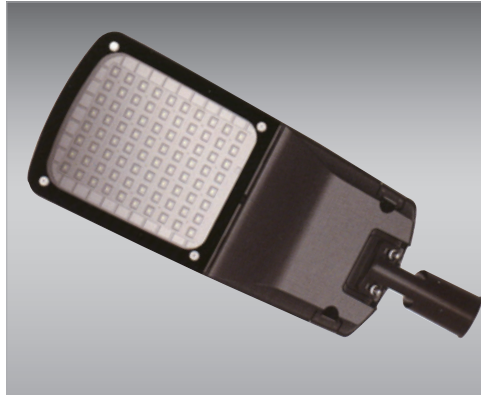
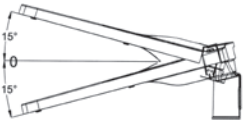
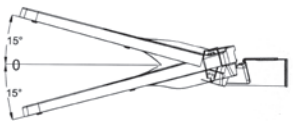
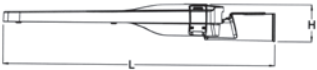
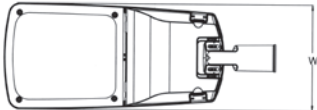

Item No.	Wattage	Lumen	LED Type	Material	Size(LxWxH)
GR1143	30W	120-145lm/w	SMD3030	Alu.	577*232.6*103.2mm
GR1143	40W	120-145lm/w	SMD3030	Alu.	577*232.6*103.2mm
GR1143	50W	120-145lm/w	SMD3030	Alu.	577*232.6*103.2mm
GR1143	60W	120-145lm/w	SMD3030	Alu.	577*232.6*103.2mm
GR1143	80W	120-145lm/w	SMD3030	Alu.	627*271.5*103.2mm
GR1143	100W	120-145lm/w	SMD3030	Alu.	627*271.5*103.2mm
GR1143	120W	120-145lm/w	SMD3030	Alu.	768*301*103.5mm
GR1143	150W	120-145lm/w	SMD3030	Alu.	768*301*103.5mm
GR1143	200W	120-145lm/w	SMD3030	Alu.	768*301*103.5mm

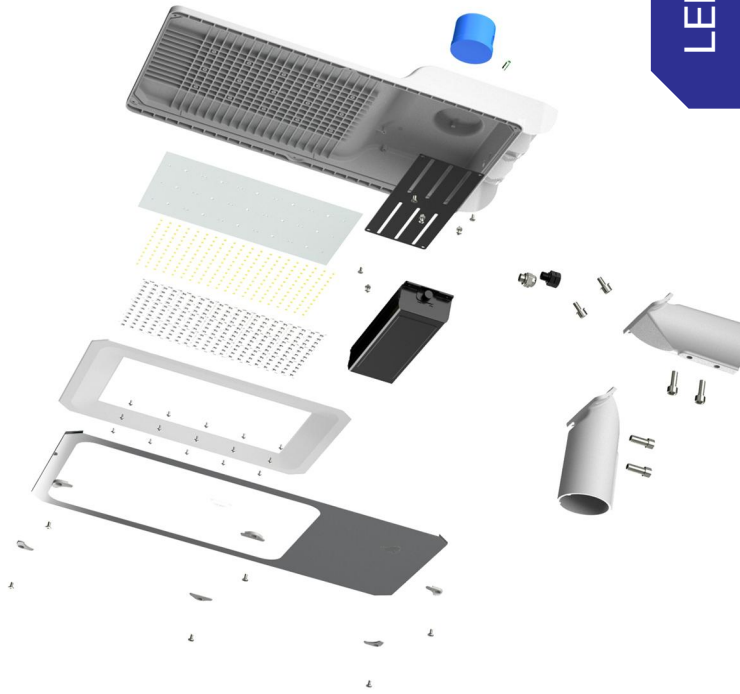

Feature

- Fashionable and modern appearance.
- Better heat radiation systems.
- Toughened glass, high strength, impact resistance.
- high reflection index anodized aluminum.



Item No.	Wattage	Material	Size(LxWxH)
GR1152	50W	Aluminium+PC	515*190*98
GR1152	100W	Aluminium+PC	575*242*109
GR1152	150W	Aluminium+PC	615*262*110
GR1152	200W	Aluminium+PC	685*287*110

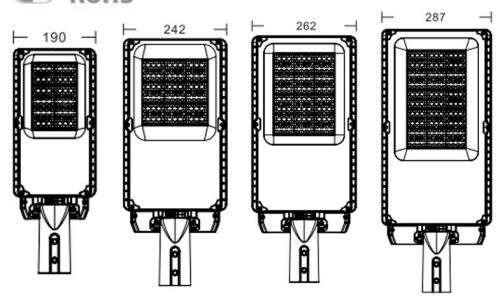





The high efficiency Len.
with compact design.
Good heat dissipation

Led UFO highbay



LED highbay is extensively applied in industrial workshops, stadiums, docks, golf courses, construction lighting, square. It can replace the traditional metal halide and light pressure sodium light.



SMD



SMD with LENS



With lampshade

Inner ring fixed color:



Available color:



Feature

- Fashion UFO Design.
- Ultra-compact size, much smaller than traditional high bay lights.
- Durable. Efficient cooling structure, much longer lifetime and quality of the high-power product is guaranteed.
- Save electricity bill. Replace HPS or MH. Save over 50% on electricity bill of lighting.
- Maintenance Free. Extremely long life reduces re-lamp frequency.
- Excellent appearance. Rugged die-cast aluminum, scratch and fade resistant Widely used.
- Ideal for commercial or industrial lighting.

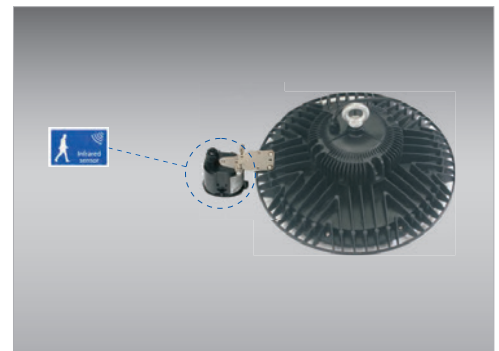
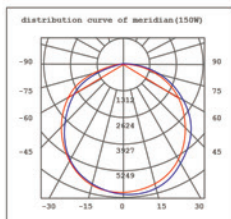
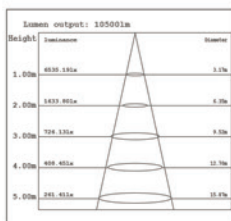
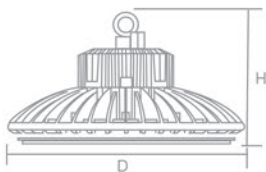

Item No.	Wattage	Lumen	LED Type	Material	Size(LxWxH)
GR1210	80W	100-130LM/W	SMD2835/3030	Alu.	320x171mm
GR1210	100W	100-130LM/W	SMD2835/3030	Alu.	320x171mm
GR1210	150W	100-130LM/W	SMD2835/3030	Alu.	320x171mm
GR1210	200W	100-130LM/W	SMD2835/3030	Alu.	430x171mm
GR1210	240W	100-130LM/W	SMD2835/3030	Alu.	430x171mm

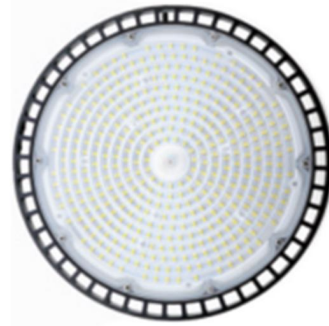

Feature

- Fashion UFO Design.
- Ultra-compact size, much smaller than traditional high bay lights.
- Durable. Efficient cooling structure, much longer lifetime and quality of the high-power product is guaranteed.
- Save electricity bill. Replace HPS or MH. Save over 50% on electricity bill of lighting.
- Maintenance Free. Extremely long life reduces re-lamp frequency.
- Excellent appearance. Rugged die-cast aluminum, scratch and fade resistant
- Widely used.
- Ideal for commercial or industrial lighting.

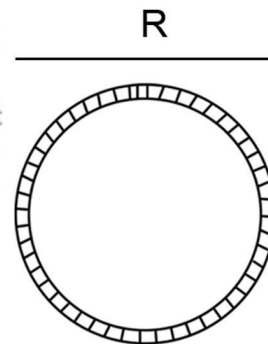

Item No.	Wattage	Lumen	Material:	Size(LxWxH)
GR1228	100W	17000LM	Aluminium+PC	Φ222*H140
GR1228	150W	25000LM	Aluminium+PC	Φ264*H145
GR1228	200W	31000LM	Aluminium+PC	Φ302*H145

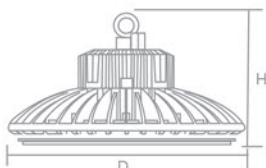

Feature

- Fashion UFO Design.
- Ultra-compact size, much smaller than traditional high bay lights.
- Durable. Efficient cooling structure, much longer lifetime and quality of the high-power product is guaranteed.
- Save electricity bill. Replace HPS or MH. Save over 50% on electricity bill of lighting.
- Maintenance Free. Extremely long life reduces re-lamp frequency.
- Excellent appearance. Rugged die-cast aluminum, scratch and fade resistant Widely used.
- Ideal for commercial or industrial lighting.

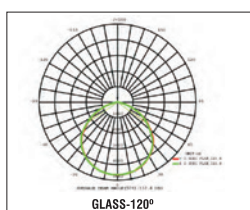
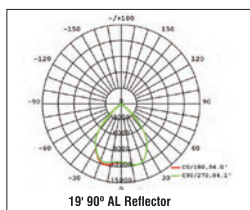

Item No.	Wattage	Lumen	LED Type	Material	Size(LxWxH)
GR1226	100W	100-110LM/W	SMD2835	Alu.	300x160mm
GR1226	150W	100-110LM/W	SMD2835	Alu.	350x160mm
GR1226	200W	100-110LM/W	SMD2835	Alu.	400x160mm



Feature

- Fashion UFO Design.
- Ultra-compact size, much smaller than traditional high bay lights.
- Durable. Efficient cooling structure, much longer lifetime and quality of the high-power product is guaranteed.
- Save electricity bill. Replace HPS or MH. Save over 50% on electricity bill of lighting.
- Maintenance Free. Extremely long life reduces re-lamp frequency.
- Excellent appearance. Rugged die-cast aluminum, scratch and fade resistant
- Widely used.
- Ideal for commercial or industrial lighting.

Item No.	Wattage	Size(LxWxH)
GR1229	100W	260*260*34mm
GR1229	150W	302*302*34mm
GR1229	200W	332*332*34mm
GR1229	300W	362*362*34mm
GR1229	400W	392*392*34mm

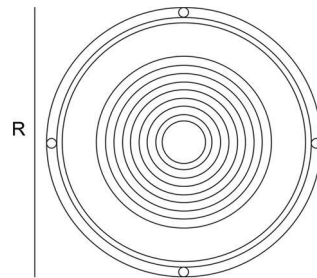



Feature

- Fashion UFO Design.
 - Ultra-compact size, much smaller than traditional high bay lights.
 - Durable. Efficient cooling structure, much longer lifetime and quality of the high-power product is guaranteed.
 - Save electricity bill. Replace HPS or MH. Save over 50% on electricity bill of lighting.
 - Maintenance Free. Extremely long life reduces re-lamp frequency.
 - Excellent appearance. Rugged die-cast aluminum, scratch and fade resistant
- Widely used.
- Ideal for commercial or industrial lighting.

Item No.	Wattage	Size(LxWxH)
GR1230	100W	270
GR1230	150W	300
GR1230	200W	350
GR1230	100W	290
GR1230	150W	330
GR1230	200W	365

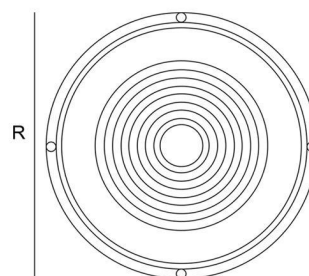



Feature

- Fashion UFO Design.
- Ultra-compact size, much smaller than traditional high bay lights.
- Durable. Efficient cooling structure, much longer lifetime and quality of the high-power product is guaranteed.
- Save electricity bill. Replace HPS or MH. Save over 50% on electricity bill of lighting.
- Maintenance Free. Extremely long life reduces re-lamp frequency.
- Excellent appearance. Rugged die-cast aluminum, scratch and fade resistant
- Widely used.
- Ideal for commercial or industrial lighting.

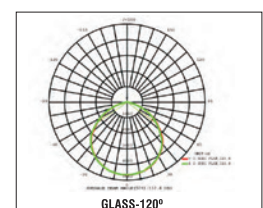
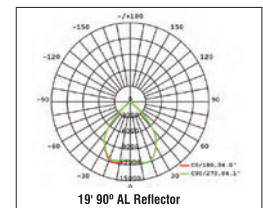
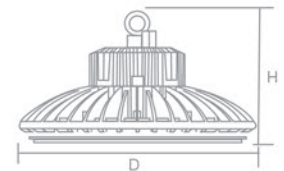

Item No.	Wattage	Lumen	LED Type	Material	Size(LxWxH)
GR1227	100W	> 12000lm	PHILIPS 3030 SMD	Alu.	280x50mm
GR1227	150W	> 18000lm	PHILIPS 3030 SMD	Alu.	337x50mm
GR1227	200W	> 24000lm	PHILIPS 3030 SMD	Alu.	400x50mm
GR1227	240W	> 28800lm	PHILIPS 3030 SMD	Alu.	400x50mm



Feature

- Economy-led highbay.
- Thickness alu die casting with tough glass.
- 90,120 degree al cover to meet the professional light distribution, suitable for different occasions.
- Taiwan led chips,high lumen efficiency.



Item No.	Wattage	Lumen	Material	Size(LxWxH)
GR1232	100W	13000LM	Aluminium+PC	Φ450*H295
GR1232	150W	18000LM	Aluminium+PC	Φ450*H295
GR1232	200W	23500LM	Aluminium+PC	Φ450*H300
GR1232	300W	35000LM	Aluminium+PC	Φ500*H340

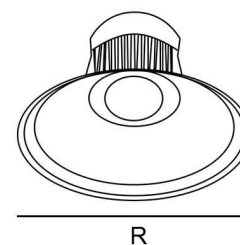



Feature

- Economy-led highbay.
- Thickness alu die casting with tough glass.
- 90,120 degree al cover to meet the professional light distribution, suitable for different occasions.
- Taiwan led chips,high lumen efficiency.

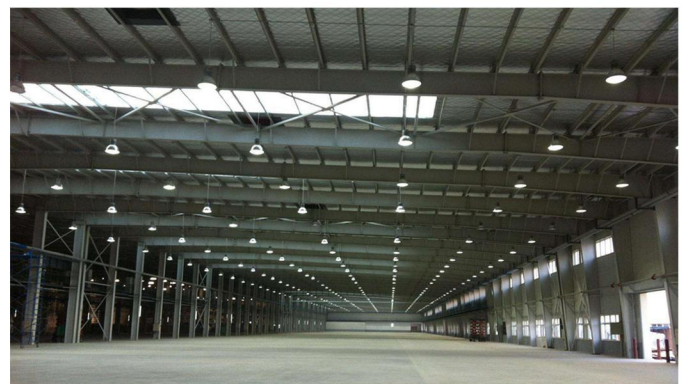

Item No.	Wattage	Lumen	Material	Size(LxWxH)
GR1231	100W	13000LM	Aluminium+PC	Φ450*H240
GR1231	150W	18000LM	Aluminium+PC	Φ490*H270
GR1231	200W	23500LM	Aluminium+PC	Φ490*H270
GR1231	300W	35000LM	Aluminium+PC	Φ425*H290

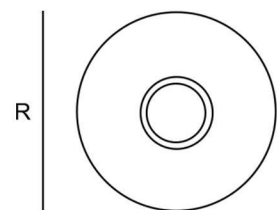



Feature

- Economy-led highbay.
- Thickness alu die casting with tough glass.
- 90,120 degree al cover to meet the professional light distribution, suitable for different occasions.
- Taiwan led chips,high lumen efficiency.

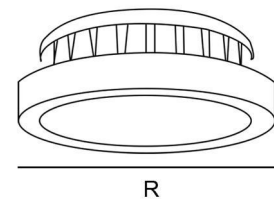
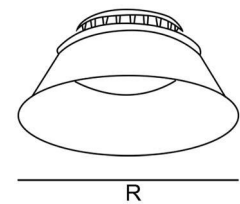

Item No.	Wattage	Lumen	Material	Size(LxWxH)
GR1234	100W	14000LM	Aluminium+PC	Φ212*H101
GR1234	150W	20000LM	Aluminium+PC	Φ245*H105
GR1234	200W	25000LM	Aluminium+PC	Φ271*H107



Feature

- Economy-led highbay.
- Thickness alu die casting with tough glass.
- 90,120 degree al cover to meet the professional light distribution, suitable for different occasions.
- Taiwan led chips,high lumen efficiency.



Item No.	Wattage	Lumen	Material	Size(LxWxH)
GR1235	100W	17000LM	Aluminium+PC	Φ290*H140
GR1235	150W	25500LM	Aluminium+PC	Φ290*H140
GR1235	200W	33000LM	Aluminium+PC	Φ380*H150
GR1235	240W	38000LM	Aluminium+PC	Φ380*H150

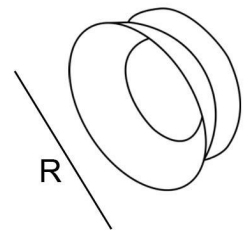

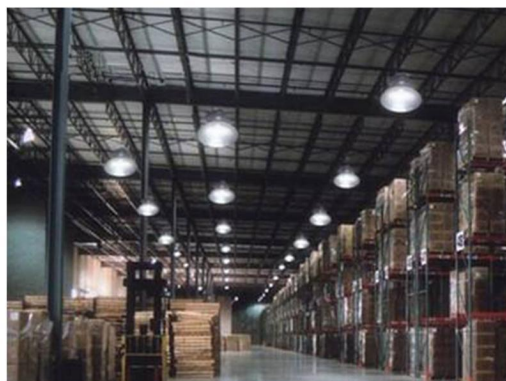

Feature

- Economy-led highbay.
- Thickness alu die casting with tough glass.
- 90,120 degree al cover to meet the professional light distribution, suitable for different occasions.
- Taiwan led chips,high lumen efficiency.

Item No.	Wattage	Lumen	Material:	Size(LxWxH)
GR1236	100W	14500LM	Aluminium+PC	Φ290*H125
GR1236	150W	21700LM	Aluminium+PC	Φ330*H130
GR1236	200W	28000LM	Aluminium+PC	Φ380*H130
GR1236	300W	36000LM	Aluminium+PC	Φ380*H140
GR1236	400W	46000LM	Aluminium+PC	Φ380*H140

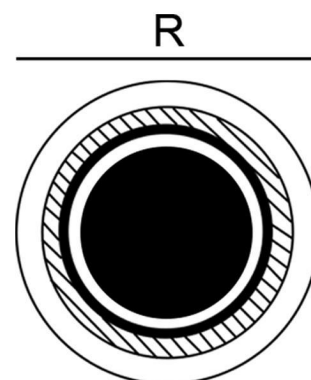

Application:

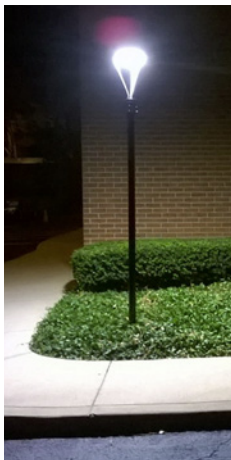

Available color:



Feature

- High strength Aluminium die casting material, surface anti-aging electrostatic spray processing, super resistance to corrosion.
- PC cover, high strength impact resistance.
- Input Voltage: AC 110-277V, 50/60Hz, IP66, IK08
- Bracket: 76mm

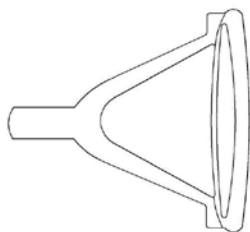
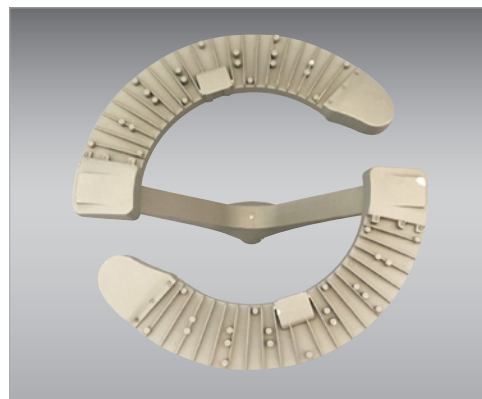
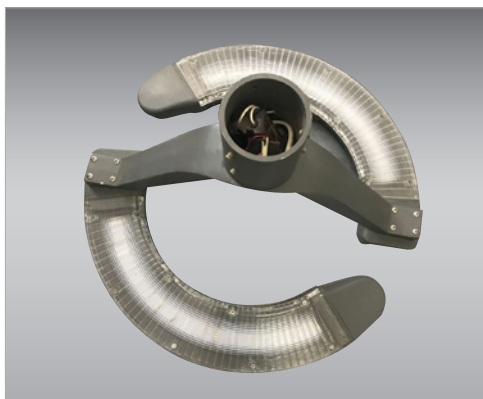
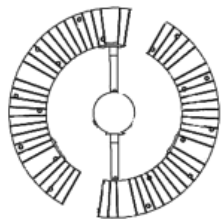
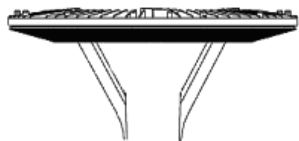

Item No.	Wattage	Lumen	LED Type	Material	Size(LxWxH)
GR1315	30W	100-110LM/W	SMD2835/3030	Alu.	623x390mm
GR1315	40W	100-110LM/W	SMD2835/3030	Alu.	623x390mm
GR1315	50W	100-110LM/W	SMD2835/3030	Alu.	623x390mm



Application:



Feature

- High strength Aluminium die casting material, surface anti-aging electrostatic spray processing, super resistance to corrosion.
- PC cover, high strength impact resistance.
- Input Voltage: AC 110-277V, 50/60Hz, IP66, IK08
- Bracket: 76mm

Available color:

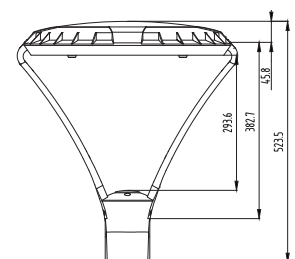
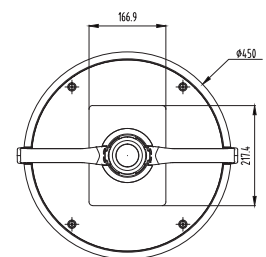
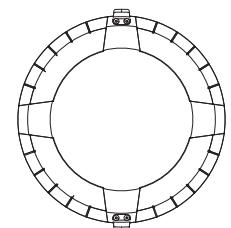

Item No.	Wattage	Lumen	LED Type	Material	Size(LxWxH)
GR1316	30W	> 130-140lm/W	PHILIPS 3030 64PCS	Alu.	Ø450*523mm
GR1316	40W	> 130-140lm/W	PHILIPS 3030 64PCS	Alu.	Ø450*523mm
GR1316	50W	> 130-140lm/W	PHILIPS 3030 64PCS	Alu.	Ø450*523mm
GR1316	60W	> 130-140lm/W	PHILIPS 3030 96PCS	Alu.	Ø450*523mm
GR1316	80W	> 130-140lm/W	PHILIPS 3030 96PCS	Alu.	Ø450*523mm
GR1316	100W	> 130-140lm/W	PHILIPS 3030 144PCS	Alu.	Ø450*523mm
GR1316	120W	> 130-140lm/W	PHILIPS 3030 144PCS	Alu.	Ø450*523mm
GR1316	150W	> 130-140lm/W	PHILIPS 3030 192PCS	Alu.	Ø450*523mm



GR1317



GR1318



Model	GR1317	GR1318
Power	15W	15W
Product Size	510x510x230mm	515x515x415mm
LED Temperature Color	2700-6500K	2700-6500K
Lumen	1650-1800lm	1650-1800lm
Working Temperature	-25°C~65°C	-25°C~65°C
Package Size	570x570x270mm 0.0877 MVCTN	575x575x455mm
N.W./G.W.	8.2kg/10.0kg	6.4kg/8.2kg
Container Loading Quantity	320sets/20' 770sets/40HQ	1set/CTN
Solar Panel	Monocrystalline Silicon-25W	
LED Chips	Bridgelux-45ML or Philips 3030	
Battery Type	High Efficiency Lithium Battery	
Solar Charging Time	7 hours by bright sunlight	
Lighting Mode	Over 3 Nights	
Install Height	3~4M	
Lighting Mode	DIM light with PIR	
Application	Street, Courtyard, Roadway, Public, Square, Parking Lot	

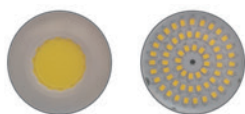

Application:



Available color:



Feature

- Save electricity bill. Replace HPS and MH.
- High CRI. CRI is over 80. More vivid and natural lighting.
- Maintenance Free. Extremely long life reduces re-lamp frequency.
- Durable housing. Rugged die-cast aluminum, scratch and fade resistant. Excellent appearance.
- No Hazardous Emissions. No UV or IR Radiation.

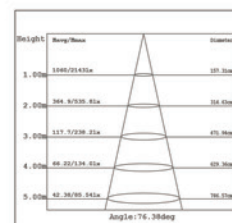

Item No.	Wattage	Lumen	LED Type	Size(LxWxH)
GR1411	60W	4800lm	COB/SMD2835	350x265x230mm
GR1411	80W	6400lm	COB/SMD2835	350x265x230mm
GR1411	120W	9600lm	COB/SMD2835	350x265x270mm
GR1411	150W	12000lm	COB/SMD2835	350x265x270mm

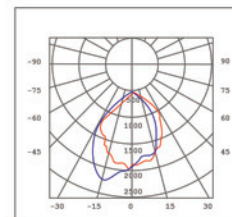

Application:



Available color:

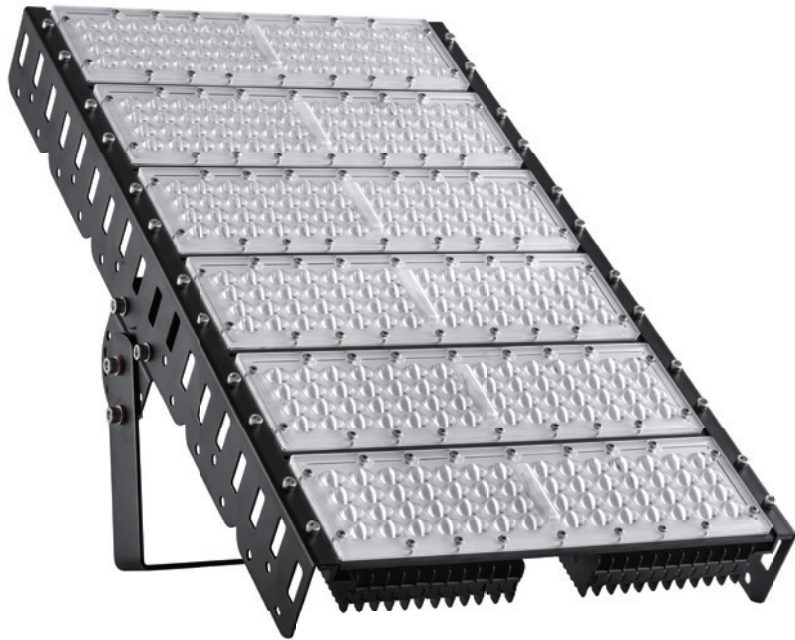

Feature

- Modular design.
- Using 1070 pure aluminum material, good heat dissipation, lighter weight, extend the service life of the light source.
- Multi lens design.
- 180 degree adjustable bracket, 13 angle adjustment point.

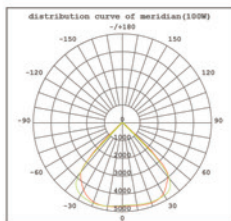
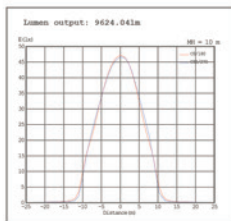
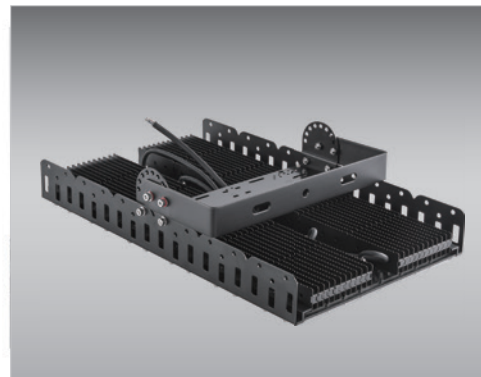
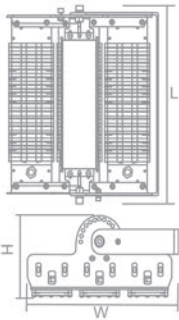

Item No.	Wattage	Lumen	LED Type	Material	Size(LxWxH)
GR1310	150W	130-140lm/w	SMD3030/SMD5050	Alu.	240x260x195mm
GR1310	200W	130-140lm/w	SMD3030/SMD5050	Alu.	348x260x195mm
GR1310	250W	130-140lm/w	SMD3030/SMD5050	Alu.	438x260x195mm
GR1310	300W	130-140lm/w	SMD3030/SMD5050	Alu.	520x260x195mm
GR1310	400W	130-140lm/w	SMD3030/SMD5050	Alu.	520x348x195mm
GR1310	500W	130-140lm/w	SMD3030/SMD5050	Alu.	520x438x195mm
GR1310	600W	130-140lm/w	SMD3030/SMD5050	Alu.	520x528x195mm



Feature

- Integrated design, using the alloy material as the main structure, has a good rust and corrosion protection function.
- Use solar power, no cable, convenient installation.
- Using lithium iron phosphate battery to extend the service life.
- Charging time:3 or 4 hours, working time:3 rainy days.

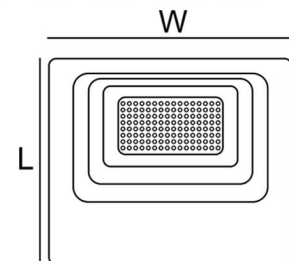

Item No.	Wattage	Material	Beam Angle	Size(LxWxH)
GRS1501	30W	Die-castAluminum+Tempered Glass	90°	270*180*17
GRS1501	50W	Die-castAluminum+Tempered Glass	90°	350*235*17
GRS1501	100W	Die-castAluminum+Tempered Glass	90°	350*235*17
GRS1501	150W	Die-castAluminum+Tempered Glass	90°	450*350*17
GRS1501	200W	Die-castAluminum+Tempered Glass	90°	530*350*17

Discharge Time: 12H and 2-3 Raining days



Feature

- Integrated design, using the alloy material as the main structure, has a good rust and corrosion protection function.
- Use solar power, no cable, convenient installation.
- Using lithium iron phosphate battery to extend the service life.
- Charging time:3 or 4 hours, working time:3 rainy days.

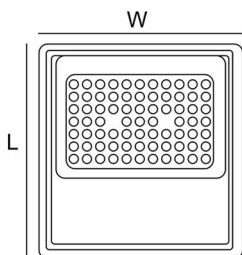

Item No.	Wattage	Material	Beam Angle	Size(LxWxH)
GRS1502	100W	Aluminium+PC	60°/90°	260*195*42
GRS1502	150W	Aluminium+PC	60°/90°	280*224*45
GRS1502	200W	Aluminium+PC	60°/90°	330*247*45

Discharge Time: 12H and 2-3 Raining days

Control Mode: Light Sensor+Timing Control+Remote Control



Feature

- Integrated design, using the alloy material as the main structure, has a good rust and corrosion protection function.
- Use solar power, no cable, convenient installation.
- Using lithium iron phosphate battery to extend the service life.
- Charging time: 3 or 4 hours, working time: 3 rainy days.

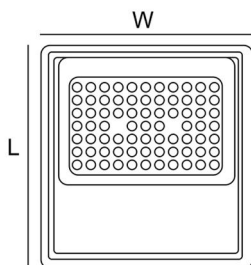

Item No.	Wattage	Material	Beam Angle	Size(LxWxH)
GRS1503	50W	Aluminium+PC	60°/90°	260*195*42
GRS1503	100W	Aluminium+PC	60°/90°	280*224*45
GRS1503	150W	Aluminium+PC	60°/90°	330*247*45
GRS1503	200W	Aluminium+PC	60°/90°	330*310*45

Discharge Time: 12H and 2-3 Raining days

Control Mode: Light Sensor+Timing Control+Remote Control

Application:



Available color:



Feature

- Solar panel: A: 6V×3W (panel size: 180×155×15mm);
B: 6V×6W (panel size: 190×290×18mm);
C: 16V×11W (panel size: 350×251×18mm).
- Battery: A: 18650 lithium battery 3.7V/4000mAh (2000mAh ×2pcs);
B: 18650 lithium battery 3.7V/6000mAh (2000mAh ×3pcs);
C: 18650 lithium battery 11.1V/12000mAh (2000mAh ×6pcs).
- Lighting mode: light sensor and ON/OFF.
- Lighting time: 8-9 hours.
- Charging time: 6-8 hours by bright sunlight.
- Wire cable: 5 meters high quality wire cable.

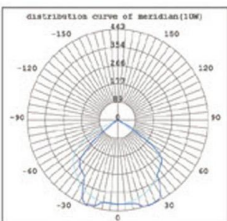
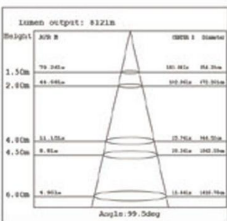
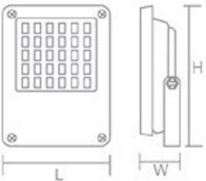

Item No.	Wattage	Lumen	LED Type	Material	Size(LxWxH)
GRS1504	30W	400lm	54PCS SMD3528	Alu.	113×85×69mm
GRS1504	50W	840lm	120PCS SMD3528	Alu.	179×45×139mm
GRS1504	100W	1224lm	18PCS SAMSUNG2835	Alu.	140×17×180mm



Feature

- Integrated design, using the alloy material as the main structure, has a good rust and corrosion protection function.
- Use solar power, no cable, convenient installation.
- Using lithium iron phosphate battery to extend the service life.
- Charging time: 3 or 4 hours, working time: 3 rainy days.



Item No.	Wattage	Material	Beam Angle	Size(LxWxH)
GRS1505	50W	Die-castAluminum+Tempered Glass	60°/90°	270*180*17
GRS1505	100W	Die-castAluminum+Tempered Glass	60°/90°	235*350*17
GRS1505	150W	Die-castAluminum+Tempered Glass	60°/90°	350*350*17
GRS1505	200W	Die-castAluminum+Tempered Glass	60°/90°	450*350*17

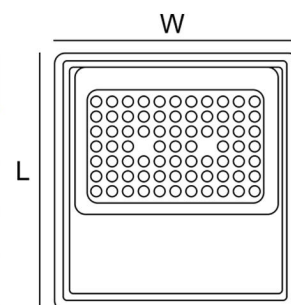

Discharge Time: 12H and 2-3 Raining days

Control Mode: Light Sensor+Timing Control+Remote Control

Application:



Feature

- Use solar power, no cable, convenient installation.
- Using lithium iron phosphate battery to extend the service life.
- Charging time: 3 or 4 hours.
- Working time: 3 rainy days.



Item No.	Wattage	Lumen	LED Type	Material	Size(LxWxH)
GRS1506	50W	1000lm	Samsung 4545LED 20PCS	Plastic	455x425x330mm
GRS1506	100W	2000lm	Samsung 4545LED 40PCS	Plastic	525x525x390mm
GRS1506	150W	3000lm	Samsung 4545LED 60PCS	Plastic	655x275x390mm
GRS1506	200W	1000lm	Bridgelux5730 LED 40PCS	Plastic	410x370x470 mm
GRS1506	250W	2000lm	Bridgelux5730 LED 80PCS	Plastic	505x370x505 mm
GRS1506	300W	3000lm	Bridgelux5730 LED 120PCS	Plastic	650x250x68 mm



Feature

- Use solar power, no cable, convenient installation.
- Using lithium iron phosphate battery to extend the service life.
- Charging time:3 or 4 hours.
- Working time:3 rainy days.



Item No.	Wattage	LED Type	Material	Size(LxWxH)
GRS1507	50W	2835 208pcs	ABS+Glass+PC	300*190*50
GRS1507	100W	2835 416pcs	ABS+Glass+PC	300*190*50
GRS1507	150W	2835 624pcs	ABS+Glass+PC	523*190*50
GRS1507	200W	2835 830pcs	ABS+Glass+PC	615*190*50

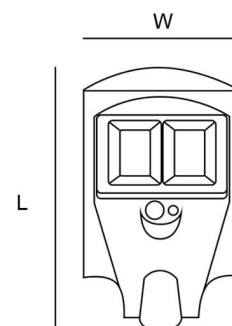

Operating Mode: Light Sensor+Remote Control+Radar

Discharge Time: 12H 3~4Rainy days

Beam Angle: 70*140°



Feature

- Use solar power, no cable, convenient installation.
- Using lithium iron phosphate battery to extend the service life.
- Charging time:3 or 4 hours.
- Working time:3 rainy days.



Item No.	Wattage	Lumen	LED Type	Size(LxWxH)
GRS1508	200W	6000LM	SMD 3030*200LEDS	1150*350*160mm
GRS1508	300W	7200LM	SMD 3030*250LEDS	1460*350*160mm

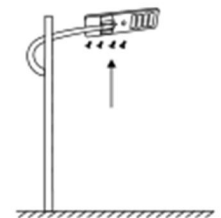
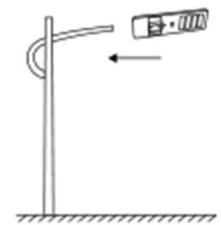



Feature

- Use solar power, no cable, convenient installation.
- Using lithium iron phosphate battery to extend the service life.
- Charging time: 3 or 4 hours.
- Working time: 3 rainy days.

Item No.	Material	Battery	Wattage	Size(LxWxH)
GRS1509	anti oxidation cast aluminum and tempered glass	20000mAh phosphate iron lithium battery	50W	350x340x17mm
GRS1509	anti oxidation cast aluminum and tempered glass	40000mAh phosphate iron lithium battery	100W	440x520x17mm

Duration of discharge: more than 10h

Charge long: 4-6h

Waterproof grade: Ip65

Product function: intelligent timing remote control / light control



Feature

- Use solar power, no cable, convenient installation.
- Using lithium iron phosphate battery to extend the service life.
- Charging time:3 or 4 hours.
- Working time:3 rainy days.

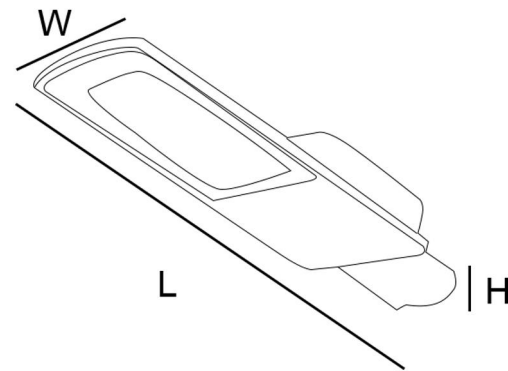

Item No.	Wattage	Led chip	Battery	Beam Angle	Solar Panel
GRS1510	100W	2835 120PCS	BYD Battery3.2V 15000mAH	70°*140°	Monocrystalline6V 15W
GRS1510	150W	2835 240PCS	BYD Battery3.2V 20000mAH	70°*140°	Monocrystalline6V 24W
GRS1510	200W	2835 480PCS	BYD Battery3.2V 20000mAH	70°*140°	Monocrystalline6V 35W

Operating Mode: Light Sensor+Timing+Remote+Control

Discharge Time: 12H 3~4Rainy days

Material: Aluminium+PC



Feature

- Use solar power, no cable, convenient installation.
- Using lithium iron phosphate battery to extend the service life.
- Charging time: 3 or 4 hours.
- Working time: 3 rainy days.



Item No.	Wattage	LED Type	Material	Size(LxWxH)
GRS1511	30W	2835 208pcs	ABS+Glass+PC	300*190*50
GRS1511	60W	2835 416pcs	ABS+Glass+PC	300*190*50
GRS1511	90W	2835 624pcs	ABS+Glass+PC	523*190*50
GRS1511	120W	2835 830pcs	ABS+Glass+PC	615*190*50

Operating Mode: Light Sensor+Remote Control+Radar

Discharge Time: 12H 3~4Rainy days

Beam Angle: 70*140°

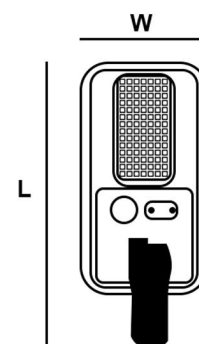



Application:

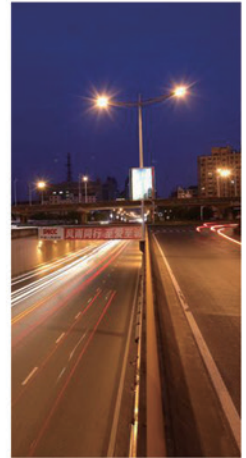

Available color:



Feature

- Use solar power, no cable, convenient installation.
- Using lithium iron phosphate battery to extend the service life.
- Charging time: 3 or 4 hours.
- Working time: 3 rainy days.

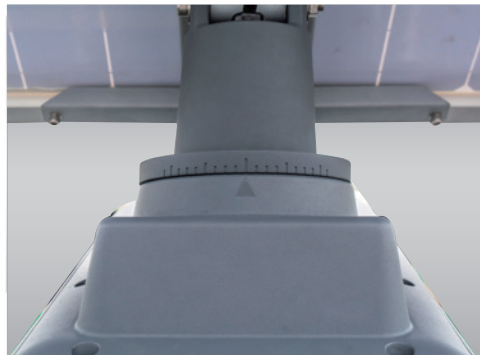

Rotated 360° horizontally

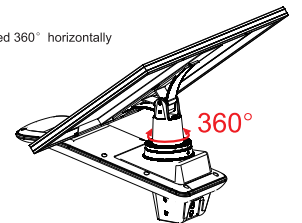

Rotated 240° vertically

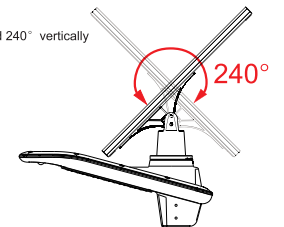

Item No.	Wattage	Solar panel	Battery	Lumen	Panel size	Lamp size
GRS1512	30W	18V 60W	244.2WH	130-150LM/W	780x513x30mm	640x260x250mm
GRS1512	60W	18V 60W	293WH	130-150LM/W	780x513x30mm	640x260x250mm
GRS1512	90W	18V 80W	341.9WH	130-150LM/W	755x670x30mm	640x260x250mm
GRS1512	120W	18V 80W	390.7WH	130-150LM/W	755x670x30mm	640x260x250mm



Feature

- Use solar power, no cable, convenient installation.
- Using lithium iron phosphate battery to extend the service life.
- Charging time:3 or 4 hours.
- Working time:3 rainy days.



Item No.	Wattage	Battery	Material	Beam Angle
GRS1513	50W	10000mAH	Aluminium+PC	70°*140°
GRS1513	100W	15000mAH	Aluminium+PC	70°*140°
GRS1513	150W	20000mAH	Aluminium+PC	70°*140°
GRS1513	200W	40000mAH	Aluminium+PC	70°*140°

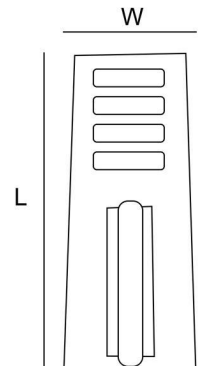

Discharge Time: 12H 3~4Rainy days



GR1118A

GR1118B

Application:

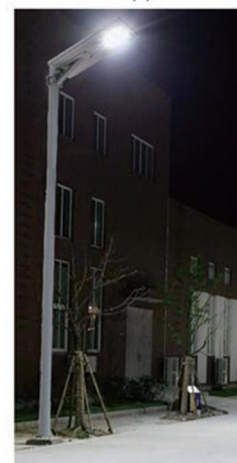

Available color:



Feature

- Integrated design, using the alloy material as the main structure, has a good rust and corrosion protection function.
- Use solar power, no cable, convenient installation.
- Using lithium iron phosphate battery to extend the service life.
- Charging time: 3 or 4 hours, working time: 3 rainy days.

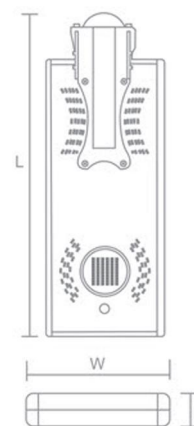

Item No.	Wattage	Lumen	Battery	Material	Size(LxWxH)
GRS1514	30W	550lm	4AH	Alu.	330×243×35mm
GRS1514	60W	880/1320lm	6AH	Alu.	505×295×70mm
GRS1514	90W	1650lm	10AH	Alu.	780×295×44mm
GRS1514	120W	1980lm	15AH	Alu.	920×295×44mm
GRS1514	150W	2200lm	18AH	Alu.	1136×295×44mm
GRS1514	180W	3300lm	21AH	Alu.	1136×295×44mm
GRS1514	210W	4400lm	24AH	Alu.	1136×295×44mm
GRS1514	240W	5500lm	36AH	Alu.	1136×420×44mm
GRS1514	270W	6600lm	42AH	Alu.	1136×420×44mm

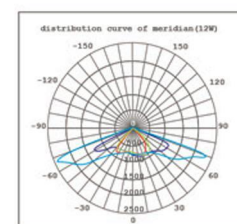



Feature

- Integrated design, using the alloy material as the main structure, has a good rust and corrosion protection function.
- Use solar power, no cable, convenient installation.
- Using lithium iron phosphate battery to extend the service life.
- Charging time:3 or 4 hours, working time:3 rainy days.

LED Number	4/7PCS	Charging	6-8hours	PCS/Ctn	400CS/Ctn
Battery	3.7V1800mAh	Working Hours	8-10hours	Guarantee	1Year
Solar panel	5.5V 7W	Housing Material	ABS	Item No.	GRS1514
Waterproof	IP65	Product size	340*270*100mm		